

use & care guide

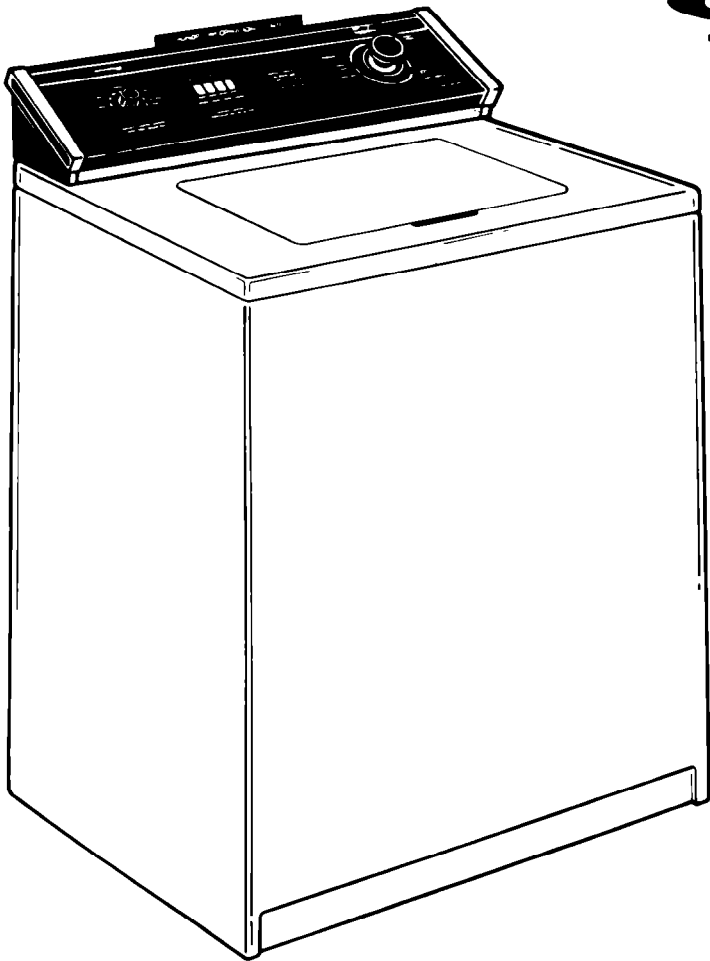

AUTOMATIC WASHER

**Super Capacity
Model
3LA5801XX**

8-92

Contents

	Page		Page
PARTS AND FEATURES	2	Liquid Bleach Dispenser	7
IMPORTANT SAFETY		MAGIC CLEAN* Lint Filter	7
INSTRUCTIONS	3	Liquid Fabric Softener	
OPERATING INSTRUCTIONS ...	4	Dispenser	7
Starting Your Washer	4	PROGRAMME GUIDE	8
OTHER OPERATING		CARING FOR YOUR WASHER ..	9
INSTRUCTIONS	6	IF YOU NEED SERVICE OR	
For a Rinse and Spin	6	ASSISTANCE	10
For a Drain and Spin	6	SERVICE CENTRES	11
For a Soak	6	WARRANTY	12

Parts and features

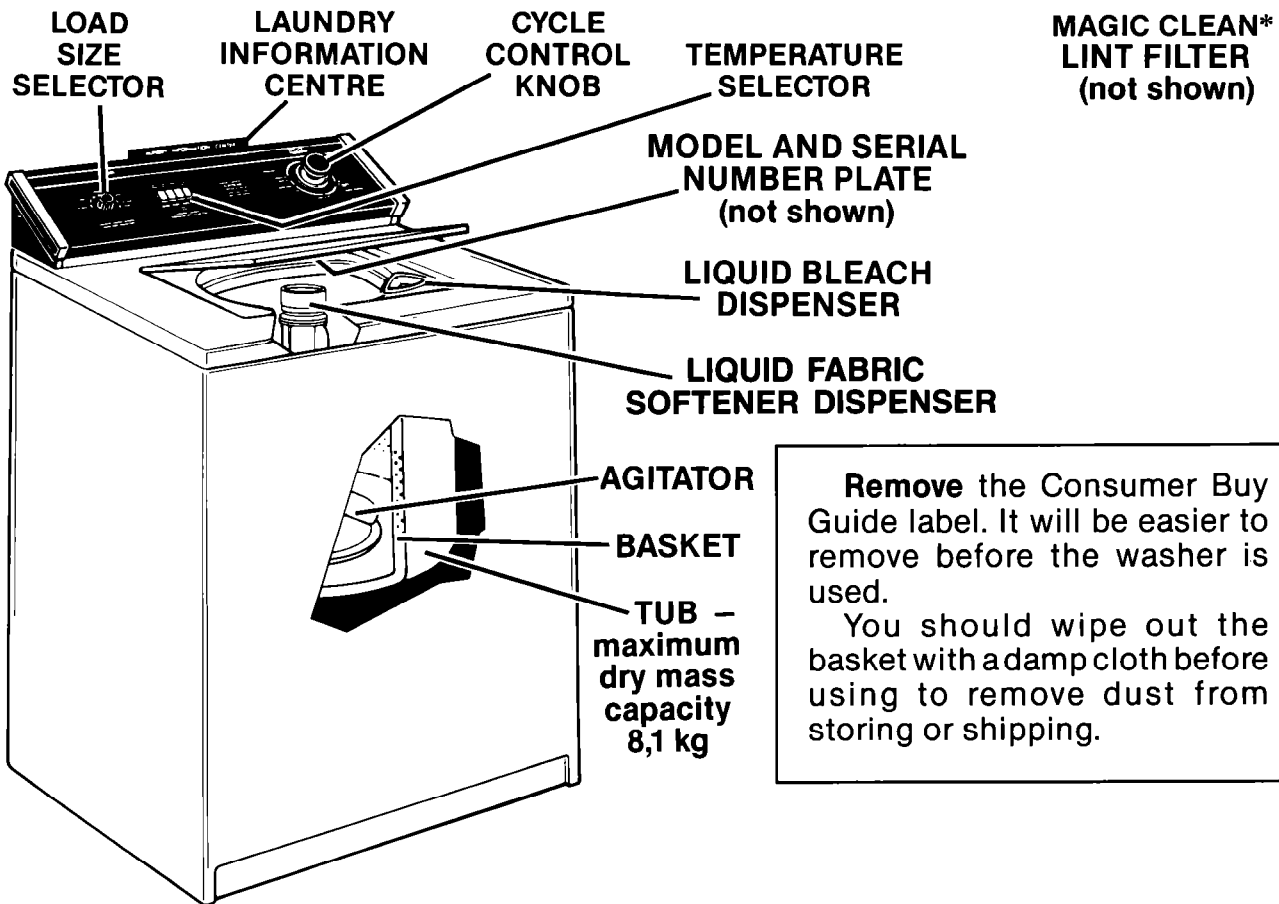

Remove the Consumer Buy Guide label. It will be easier to remove before the washer is used.

You should wipe out the basket with a damp cloth before using to remove dust from storing or shipping.

Copy your Model and Serial Numbers here

When you need service or call with a question, have this information ready:

- Complete Model and Serial Numbers** (from plate under the lid near the hinge).
- Purchase date from sales slip.

Copy this information in these spaces. Keep this book, your "Laundry Guide" and Sales slip.

Model Number _____

Serial Number _____

Purchase Date _____

Service Company _____
Phone Number _____

Important safety instructions

⚠ WARNING

To reduce the risk of fire, electric shock, or injury to persons when using your washer, follow basic precautions, including the following:

- **Read all instructions before using the washer.**
- **NEVER** wash items cleaned, washed, soaked in or spotted with wax, paint, gasoline, or flammable fluids in the washer. The fumes can create a **FIRE HAZARD** or **EXPLOSION**. **ALWAYS** hand launder and air dry fabrics containing these materials.
- **NEVER** allow children to operate, play with, or crawl inside the washer. Close supervision of children is necessary when the washer is used near children.
- When discarding an old washer, **ALWAYS** remove the lid to prevent accidental entrapment.
- **DO NOT** reach into the washer basket while it is filling with water, while agitator is moving or while basket is spinning. If the lid is opened while the basket is spinning, the basket will automatically stop in a few seconds.
- **DO NOT** tamper with controls.
- **NEVER** use or store flammable fluids (dry-cleaning solvents, kerosene) in or near your washer. **DO NOT** add flammable fluids to the wash water. These substances give off vapors that can create a **FIRE HAZARD** or **EXPLOSION**.
- If hot water has not been used recently (usually 2 weeks or longer), hydrogen gases may build up in the water heater and the hot water pipes. **HYDROGEN GAS IS EXPLOSIVE**. To prevent injury or damage, before using your washer, turn on all hot water faucets and allow water to run for several minutes. This will allow gases to escape. **DO NOT** smoke or use any open flame near the faucet while it is open.
- **You are responsible for making sure that your washer:**
 - is installed, repaired, and has parts replaced by a qualified person.
 - is properly installed and leveled on a floor that can support the weight*.
 - is connected to the correct 3-prong outlet, electric supply, water supply and drain*.
 - is properly earthed*.
 - is properly maintained*.
 - is protected from the weather and kept where the temperature will not fall below freezing.

*See the "Installation Instructions."

– SAVE THESE INSTRUCTIONS –

Additional safety instructions and your responsibilities

ALWAYS store detergent, laundry aids and other materials in a cool, dry place where children can't reach them – in a locked cabinet if possible.

ALWAYS read and follow instructions on packages of detergents and laundry aids – especially warnings and precautions.

HAZARDOUS FUMES can be formed if chlorine bleach is used in the same wash as ammonia or acids such as vinegar or rust remover.

ALWAYS unplug the power supply cord before attempting to service the washer.

DO NOT machine wash glass fibre materials. Small particles can stick to fabrics washed in following loads and cause skin irritation.

You are responsible for making sure that your washer:

- is used only for jobs normally expected of home automatic washers.
- is not run by children or anyone unable to operate it properly.

Operating instructions

Starting Your Washer



Be sure to measure and add low foaming, automatic washing machine detergent, then place a sorted load in the washer before commencing with the cycle. Detergents should be predissolved when the wash water temperature is less than 40°C.

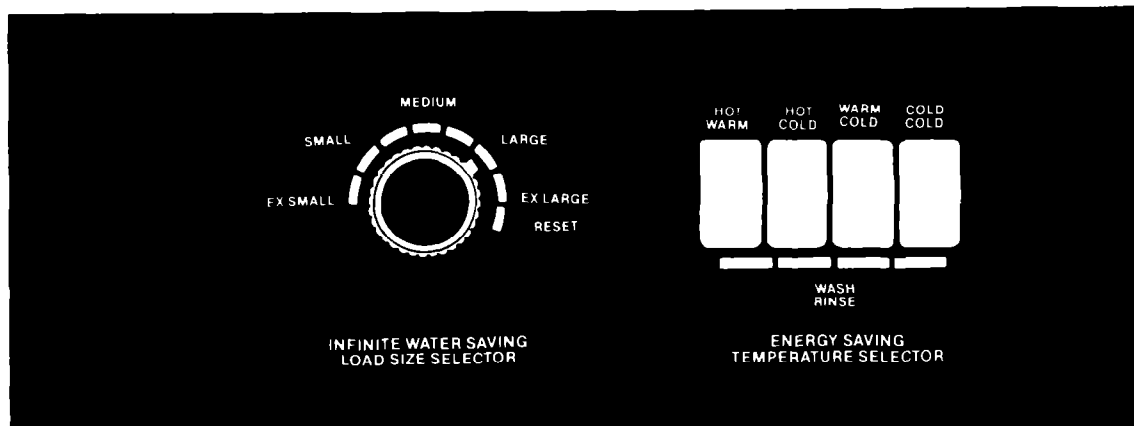

1. Select a LOAD SIZE

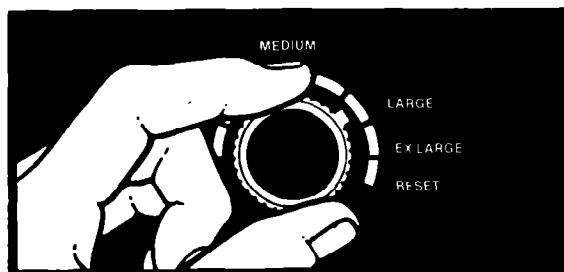

- Turn the knob to point at a setting that describes the size of load you want to wash.
- Set the knob anywhere on or between EX SMALL (a few small items) and EX LARGE (a full load).
- To change the water level after the washer has started to fill, turn the knob to RESET, then the desired water level.

NOTE: Use the EX LARGE water level for best permanent press results.

2. Select WATER TEMPERATURES

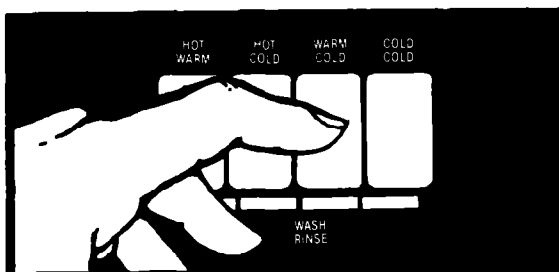

- Select wash and rinse water temperatures by pushing a button.
- This drawing shows a warm wash (top temperature) and cold rinse (bottom temperature) selection.

Recommended wash temperatures can be found in your "Laundry Guide".

IMPORTANT: Use warm water with the PERM'T PRESS or KNITS/GENTLE cycles. For heavily soiled permanent press or knit clothes, pre-soak before washing in warm water.

LOAD SIZES AND WATER LEVELS

For best cleaning results, the load must be able to move freely in the water. Too big a load or too little water can cause wear or tearing of load items.

Approximate fill with load

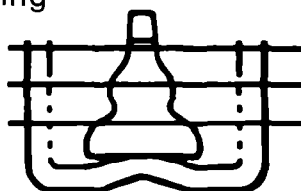

CAUTION:
DO NOT
OVERLOAD WASHER.

EX LARGE 82,1 ℓ
MEDIUM 62,1 ℓ
EX SMALL 45,0 ℓ

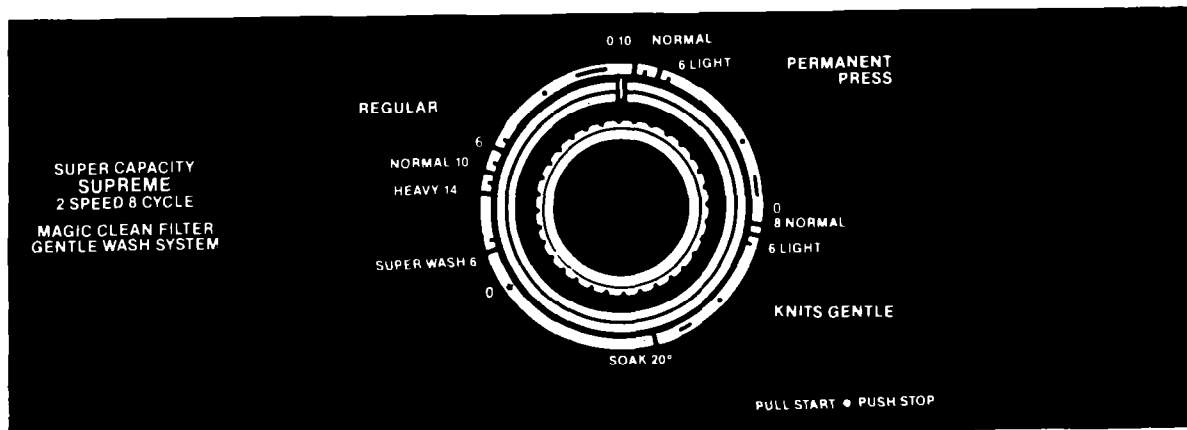

**3. Select CYCLE and WASH TIME;
Start the washer**

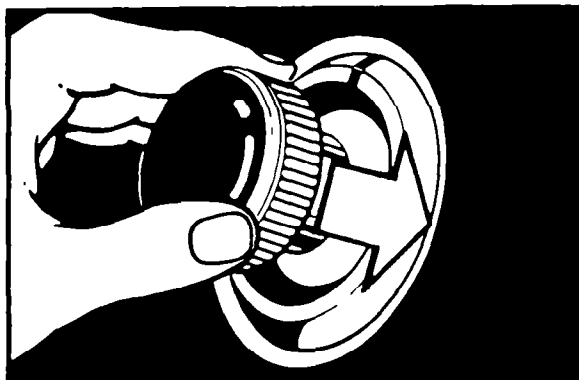

A. Push in the Control Knob and turn it to the right. It must be pushed in and turned only clockwise.

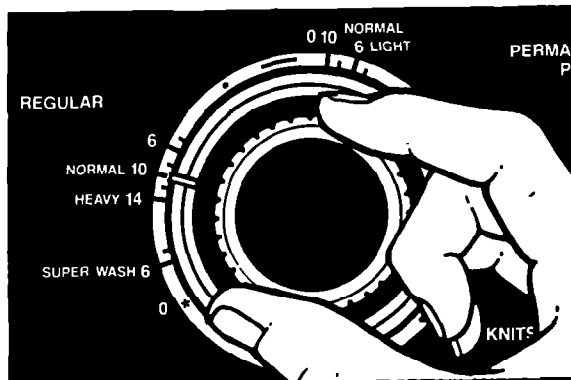

B. Stop on a number in the cycle you want. The numbers are minutes of wash time. The drawing shows 10 minutes of agitation in the REGULAR NORMAL Cycle.

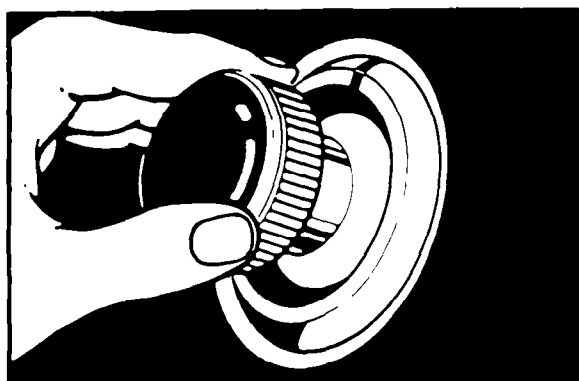

C. Start the washer by pulling out the Control Knob. The washer will fill to the level you set with wash water of the selected temperature. After filling, the washer will agitate for the selected number of minutes.

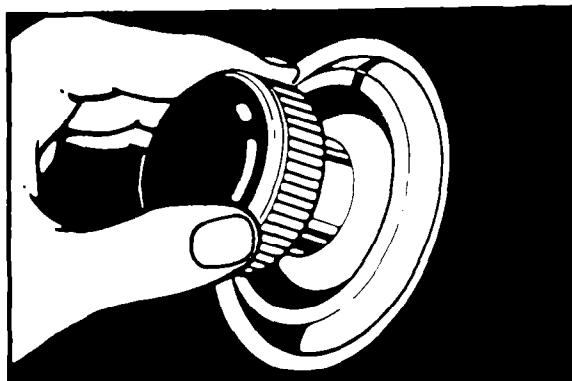

D. To stop the washer at any time, push in the Control Knob. To restart the washer, pull out the Control Knob.

Other Operating instructions

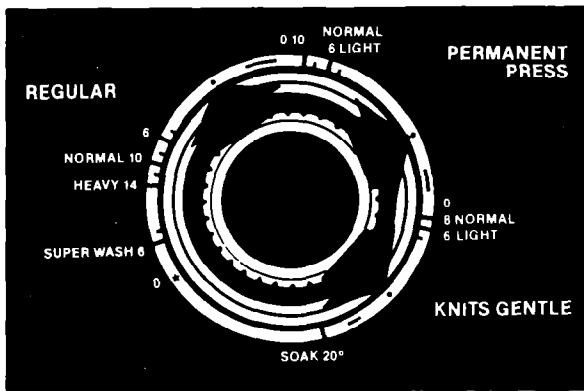

For a rinse and spin

You may need an extra rinse and spin for heavily soiled loads which need more detergent. (Extra detergent can require an extra rinse.)

1. Push Control Knob in.
2. Turn clockwise to any ● on the dial. **See above drawing.**
3. Pull Control Knob out. The washer will fill to selected level; agitate 2 minutes; drain and spin.

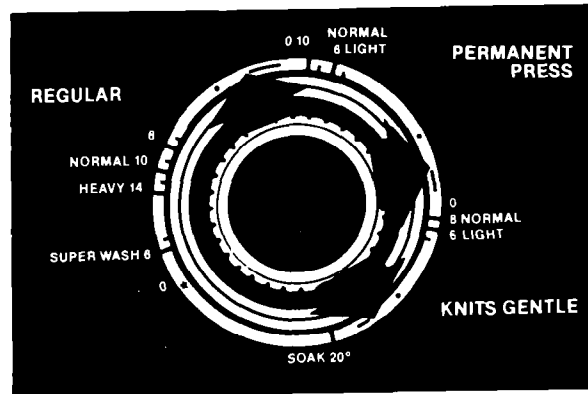

For a drain and spin

Your washer can be set to drain and spin out water.

1. Push Control Knob in.
2. Turn clockwise to the bar just before the OFF area in any cycle. **See above drawing.**
3. Pull Control Knob out. The washer will drain and spin.

For a soak

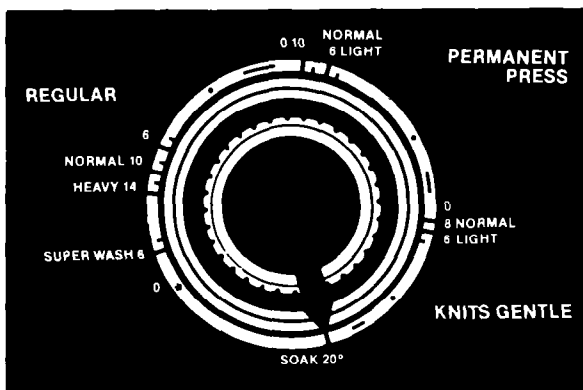

For best results, use **warm** water for soaking or pre-washing stained laundry. **Hot water can set stains.**

1. Use recommended amount of detergent or pre-soak product.
2. Push Control Knob in.
3. Turn clockwise to point to the **number** in the SOAK Cycle.
4. Pull Control Knob out. The washer will start.
5. When the cycle is over, add detergent for the next selected wash cycle. **The SOAK Cycle should always be followed by a Wash Cycle.**

Important: See additional care information in your "Laundry Guide".

Liquid bleach dispenser

Always measure bleach. Do not guess. Never use more than 1 cup (250 ml) for a full load. Use less with lower water level settings. Follow directions on bottle for safe use. Use a cup with a pouring spout to avoid spilling.

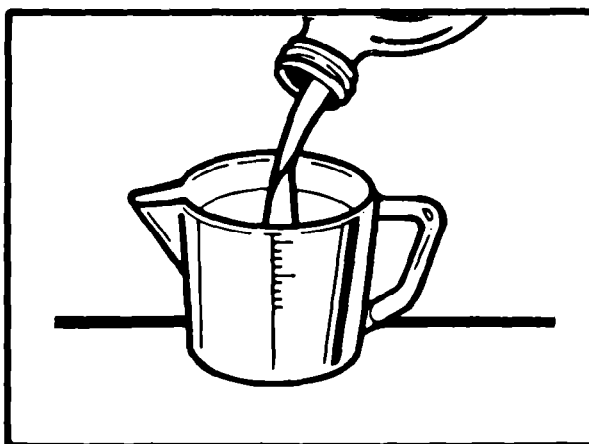
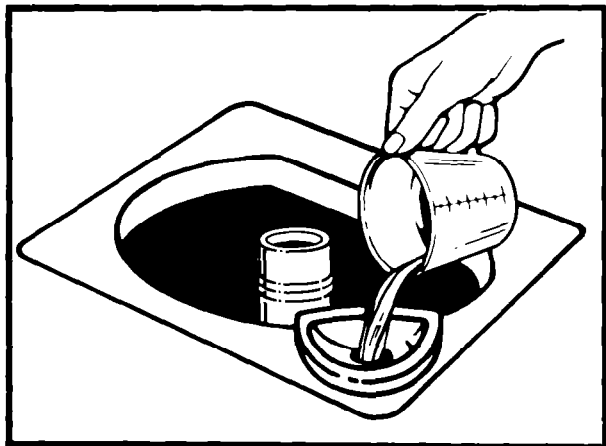

1. Load the washer first.
2. Pour **measured** bleach carefully into dispenser. **DO NOT** let bleach splash, drip or run down into the washer basket. **Undiluted bleach will damage any fabric it touches.**
3. Start the washer. Bleach will be diluted automatically during the wash part of the cycle.

For more information on bleaching, see your "Laundry Guide".

MAGIC CLEAN* lint filter

The lint filter in your washer cleans itself. Collected lint is drained away with the wash and rinse water.

If your washer drains into a tub, remove any lint collected in the drain or strainer.

Liquid fabric softener dispenser

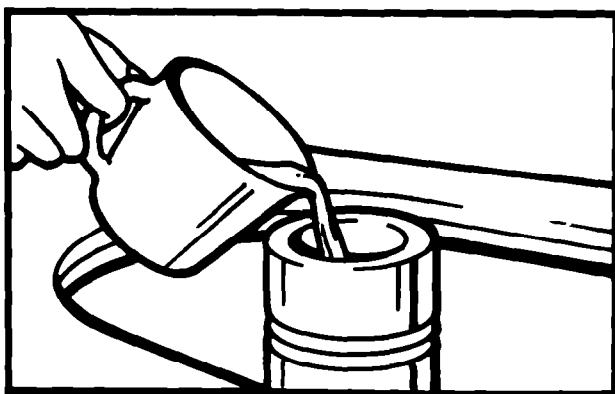

1. Add detergent and load to the basket.
2. Add liquid fabric softener to the dispenser using the amount recommended on the bottle.
3. Avoid dripping or spilling any fabric softener on the load.
4. **Dilute** fabric softener with hot water. The quantity of diluted fabric softener should not exceed 150 ml per fill.
5. Start the washer. Diluted fabric softener will be added to the load during the final rinse portion of the cycle. **NOTE: Do not stop the washer during this time.** If you do, the softener will mix with the remaining soapy wash water. This will cause stains. **Do not put detergent in the liquid fabric softener dispenser.**
6. If dispenser needs cleaning, flush with hot water.

Programme guide

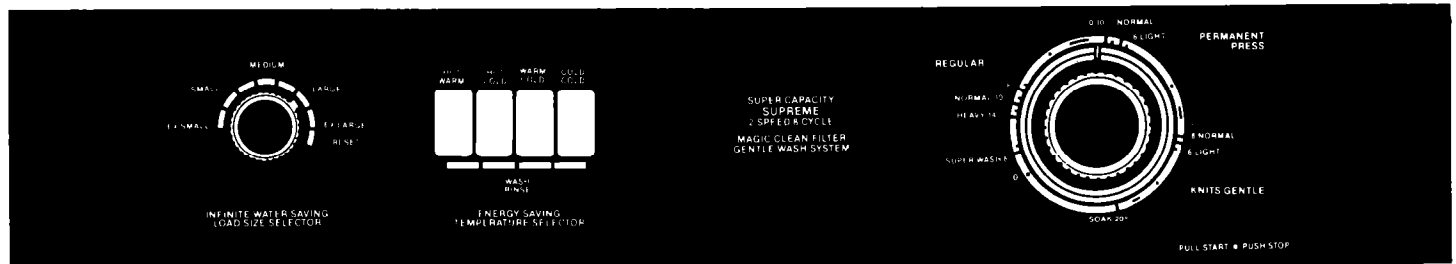

FABRIC	OPERATION	LOAD SIZE	DETERGENTS	WATER TEMP. WASH/RINSE	PROGRAMME SELECTOR	BLEACH	FABRIC SOFTENER
1. Heavy soiled natural fibre fabrics e.g.: linen or white cottons	8 min. High Speed Wash 6 min. Low Speed Wash 2 min. High Speed Spin 1 Rinse 2 Spray Rinses 6 min. Final High Speed Spin	As per Load	Ref. Laundry Guide	Hot/Warm	Regular Heavy No - 14	Yes	Yes
2. Heavy soiled natural fibres e.g.: Linen, cotton, denim and colour fast fabrics	8 min. High Speed Wash 6 min. Low Speed Wash 2 min. High Speed Spin 1 Rinse 2 Spray Rinses 6 min. Final High Speed Spin	As per Load	Ref. Laundry Guide	Hot/Warm	Regular Heavy No - 14		Yes
3. Normally soiled natural fibres e.g.: linen, cotton, denim, and colour fast natural fibre fabrics	4 min. High Speed Wash 6 min. Low Speed Wash 2 min. High Speed Spin 1 Rinse 2 Spray Rinses 6 min. Final High Speed Spin	As per Load	Ref. Laundry Guide	Hot/Cold	Regular Normal No - 10		Yes
4. Moderately soiled permanent press fabrics and mixed colour fast fabrics	4 min. High Speed Wash 6 min. Low Speed Wash 1 Cool Down Intake 2 min. High Speed Wash 2 min. High Speed Spin 1 Rinse 2 Spray Rinses 4 min. Final Low Speed Spin	Extra Large	Ref. Laundry Guide	Warm/Cold	Permanent Press Normal No - 10		Yes
5. Lightly soiled permanent press fabrics and mixed colour fast garments	6 min. Low Speed Wash 1 Cool Down Intake 2 min. High Speed Wash 2 min. High Speed Spin 1 Rinse 2 Spray Rinses 4 min. Final Low Speed Spin	Extra Large	Ref. Laundry Guide	Warm/Cold	Permanent Press Light No - 6		Yes
6. Moderately soiled gentle items and washable knits	8 min. Gentle Wash 2 min. High Speed Spin 1 Rinse 2 Spray Rinses 4 min. Final Low Speed Spin	Extra Large	Ref. Laundry Guide	Warm/Cold	Knits/Gentle Normal No - 8		Yes
7. Lightly soiled gentle items and washable knits	6 min. Gentle Wash 2 min. High Speed Spin 1 Rinse 2 Spray Rinses 4 min. Final Low Speed Spin	Extra Large	Ref. Laundry Guide	Warm/Cold	Knits/Gentle Light No - 6		Yes
8. Heavy soiled clothing with stains that need extra pre-treatment. This cycle should always be followed by a wash cycle	4 min. High Speed Wash 4 min. Soak 2 min. High Speed Wash 4 min. Soak 6 min. High Speed Wash 2 min. Final High Speed Spin	As per Load	Detergent or pre-soak additive	Warm or Cold	Soak Cycle No - 20		
9. Heavy soiled garments that require maximum soil removal. This cycle normally follows the soak cycle	4 min. High Speed Wash 1 Partial Drain and advances to the Heavy Regular Cycle. (No 14)	As per Load	Double Amount of Detergent	Hot/Cold	Super Wash No - 6		

Caring for your washer

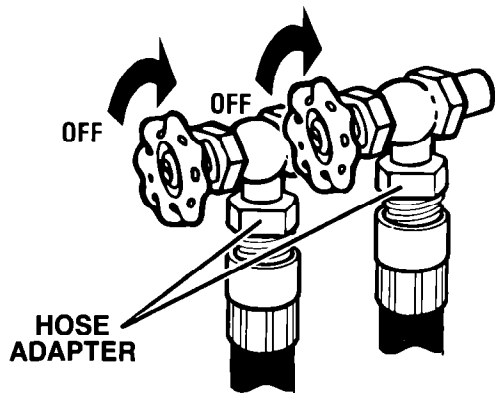

WHEN NOT WASHING, keep both water faucets turned off, this takes the pressure off the water inlet valve and hoses.



Wipe up spills right away. Spills can dull or damage the finish.

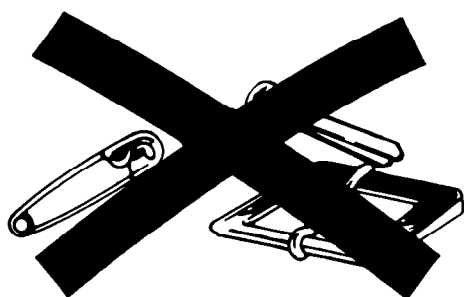

REMOVE SHARP OBJECTS such as pins, buckles, etc., from clothes before washing. Close metal zippers.

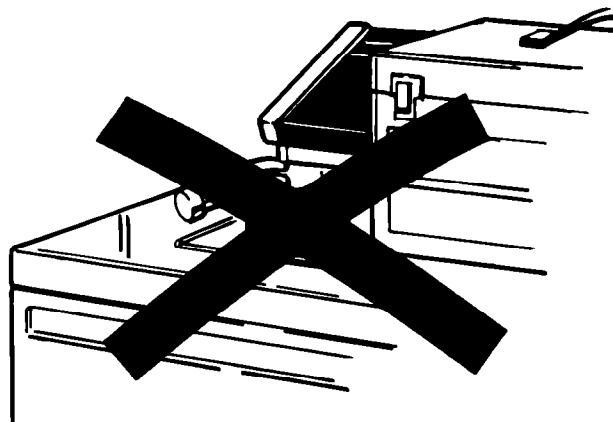

SHARP OR HEAVY OBJECTS should never be put on or in the washer. Check pockets for bolts, nuts, tools, etc.



NEVER USE THE WASHER TO . . .

- store wet or dry laundry.
- soak for more than 2 hours.
- soak with chlorine bleach.
- soak with vinegar or other acids.
- soak or store urine soaked clothes.



SOME PRETREATMENT PRODUCTS can damage washer and dryer dials, consoles and finishes. Do not use these products on or near your washer or dryer.

If you need service or assistance, we suggest you follow these steps:

1. Before calling for assistance . . .

Performance problems often result from little things you can find and fix yourself without tools of any kind.

If your washer does not fill:

- Is the power supply cord plugged into a live circuit with the proper voltage?
- Are both water faucets open?
- Have you checked your home's main fuses or circuit breaker box?
- Are the water supply hoses kinked?
- Is the Cycle Control Knob set and pulled out?

If your washer does not spin:

- Is the lid closed?
- Is the power supply cord plugged into a live circuit with the proper voltage?
- Have you checked your home's main fuses or circuit breaker box?

If your washer stops during a cycle:

- Remember, the washer pauses briefly at different times in each cycle. These pauses are normal.

If your washer fills and drains without running:

- Make sure that the Cycle Control Knob is pointing to a number in the cycle.

Make sure the drain hose is higher than the water level in the washer. If it isn't:

- The washer may seem to be draining during wash and rinse cycles.
- Water can siphon out. (See "Installation Instructions".)

2. If you moved . . .

To make sure that your appliance is correctly installed and to ensure its continued satisfactory operation, call your dealer. (Installation cost must, of course, be paid by you.)

3. Helpful hints . . .

You can help your service representative give faster service if you include the model and serial number of your appliance when requesting service. Also, retain your sales slip and warranty to verify your warranty status.

Remember . . . Your service representative is trained in repairing and servicing your Whirlpool appliances. He can help you maintain the quality originally built into your WHIRLPOOL appliance. So . . . take the time now to look up his telephone number and **jot it down in the space provided on page 2.**

4. If you need service . . .

The care of your Whirlpool washer is entrusted to the nationwide service network of K.I.C. Limited – the company that guarantees No. 1 after-sales service.

YOUR K.I.C. SERVICE CENTRES ARE IN:

CAPE TOWN	(021) 25-2070
JOHANNESBURG	(011) 887-6610
DURBAN	(031) 700-4361
PORT ELIZABETH	(041) 54-3484
BLOEMFONTEIN	(051) 32-4733/4
KIMBERLEY	(0531) 81-2588
WINDHOEK	(061) 3-8925

Provided your locality is no further than 50 km from the nearest K.I.C. Service Centre, no travelling charges will be levied if your appliance is still under warranty. Travelling charges beyond this 50 km radius will be for the owner's account.

The manufacturers reserve the right to modify and alter their products at all times without prior notification.

Warranty by K.I.C. Limited

K.I.C. warrants to the original purchaser for a period of 24 months from the date of purchase that the article identified by the serial label/plate is free of defects in material and workmanship under normal use and service, subject to the provisions of clauses 1 to 13 hereinbelow:

- 1.1 At any time within the warranty period K.I.C. will cause to be replaced or repaired any part found by K.I.C. to be defective.
- 1.2 K.I.C. shall have an unfettered discretion to have a part/parts repaired as opposed to having same replaced.
2. In the event of a defect to an article requiring to be remedied in terms of this warranty, provided the article is in a locality no further than 50 kilometres from a K.I.C. branch or the nearest K.I.C. designated repairer no charge in respect of travelling time and travelling expenses will be levied. Outside the 50 kilometre radius the purchaser will be liable to K.I.C. or the repairer for travelling time and travelling expenses in accordance with the prevailing rate of charges from time to time of K.I.C. or its designated repairer (whichever may be applicable), such charges to be levied only as regards the excess kilometres travelled beyond the 50 kilometre radius, the said charges to apply mutatis mutandis to the service engineer's return journey.
3. Anything to the contrary herein contained notwithstanding, the defect must be due entirely to faulty materials or faulty manufacture.
4. The warranty excludes defects caused to the article arising from a failure to adhere to instructions given in this booklet, incorrect voltages or faults in the electrical power system, damage caused by lightning, strikes, misuse or abuse of the article, use of the article for purposes other than that for which it was designed, fire, flood, war, civil disturbance, industrial action, acts of God or any other cause beyond the reasonable control of K.I.C.
- 5.1 K.I.C. shall not, under any circumstances whatsoever, be liable for any damages sustained due to failure of operation or malfunctioning of the article, nor for consequential damages of whatsoever nature, howsoever arising.
- 5.2 Without derogating from the generality of the foregoing, K.I.C. shall not be liable for any damages arising from the malfunctioning and/or damage of/to the article arising from foreign objects finding their way into the working parts of the article, e.g. a coin blocking a washing machine pump.
6. The warranty does not apply to fuses, styli, external plugs, cables, plastic, rubber and glass parts, nor will it apply in the event of an article designed for normal domestic use being used for commercial, industrial or any purpose for which it was not designed.
7. This warranty shall furthermore not be applicable should the article be dismantled/serviced/ repaired/modified in any way by anyone other than K.I.C. or its designated repairer or any party authorised by K.I.C. thereto, nor in the event of the defacement or renewal of the serial label/plate.
8. The warranty shall apply to the article only while same is, still owned and possessed by the original purchaser and provided that it was purchased and retained for use in the Republic of South Africa, Swaziland, Lesotho, Botswana, Namibia, Transkei, Ciskei, Venda, Bophuthatswana, Lebowa.
9. Any defective part which has been replaced shall become the property of the repairer.
10. In the case of a cash sale (as opposed to a credit agreement subject to the provisions of the Credit Agreements Act, 1980, or any amending or substituted legislation) this warranty replaces any liability of K.I.C. at common law in respect of latent defects.
11. Repairs effected or parts replaced in terms of this warranty will be subject to warranty only for the duration of the balance of the original warranty period relating to the article.
12. The purchaser hereby acknowledges that no representations or warranties other than those set out herein have induced the purchaser to purchase this article, or form part of the contract of purchase and sale of this article.
13. Evidence as to the date of purchase must be produced by the purchaser at the material time to obtain the benefit of this warranty.

*Registered Trademark of Whirlpool Corporation

gebruiks-en versorgingsgids

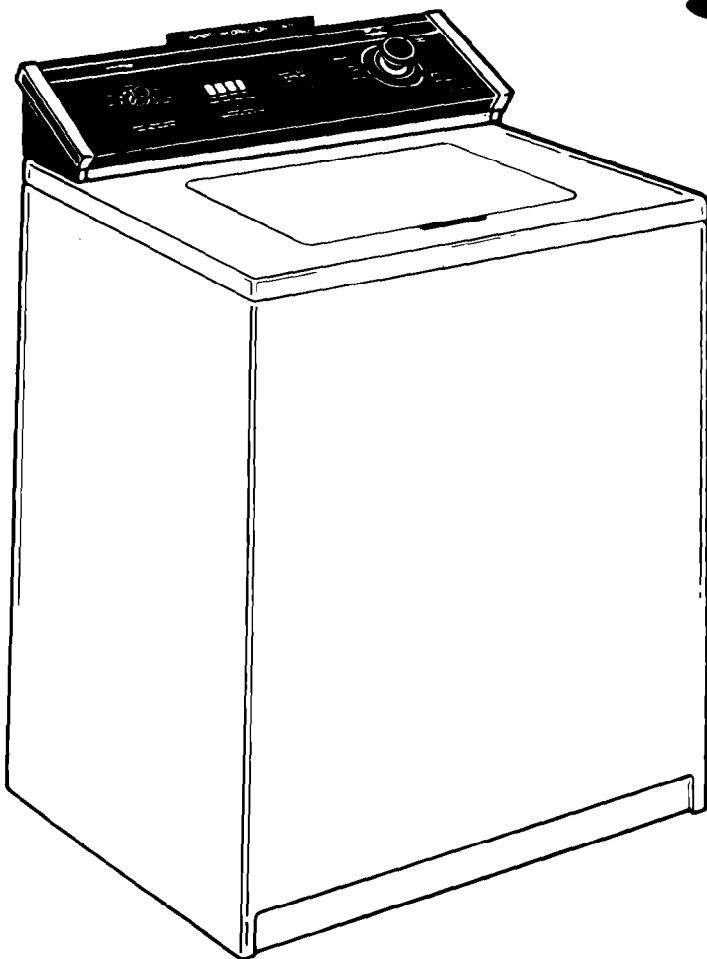

OUTOMATIESE WASMASJEN

**Super-Kapasiteit
Model
3LA5801XX**

Inhoud

	Bladsy		Bladsy
ONDERDELE EN KENMERKE	2	MAGIC CLEAN* Pluisfilter.....	7
BELANGRIKE VEILIGHEIDSMATREËLS	3	Houer vir Vloeibare Wasgoedversagmiddel.....	7
GEBRUIKSAANWYSINGS	4	PROGRAMGIDS	8
Om Wasmasjien aan te Skakel ...	4	VERSORGING VAN U	
ANDER GEBRUIKSAANWYSINGS	6	WASMASJEN	9
Vir Spoel en Wentel.....	6	INDIEN U DIENS OF HULP	
Vir Dreineer en Wentel	6	NODIG HET	10
Vir Week	6	DIENSSENTRUMS	11
Houer vir Vloeibare Bleikmiddel ..	7	WAARBORG	12

Onderdele en kenmerke

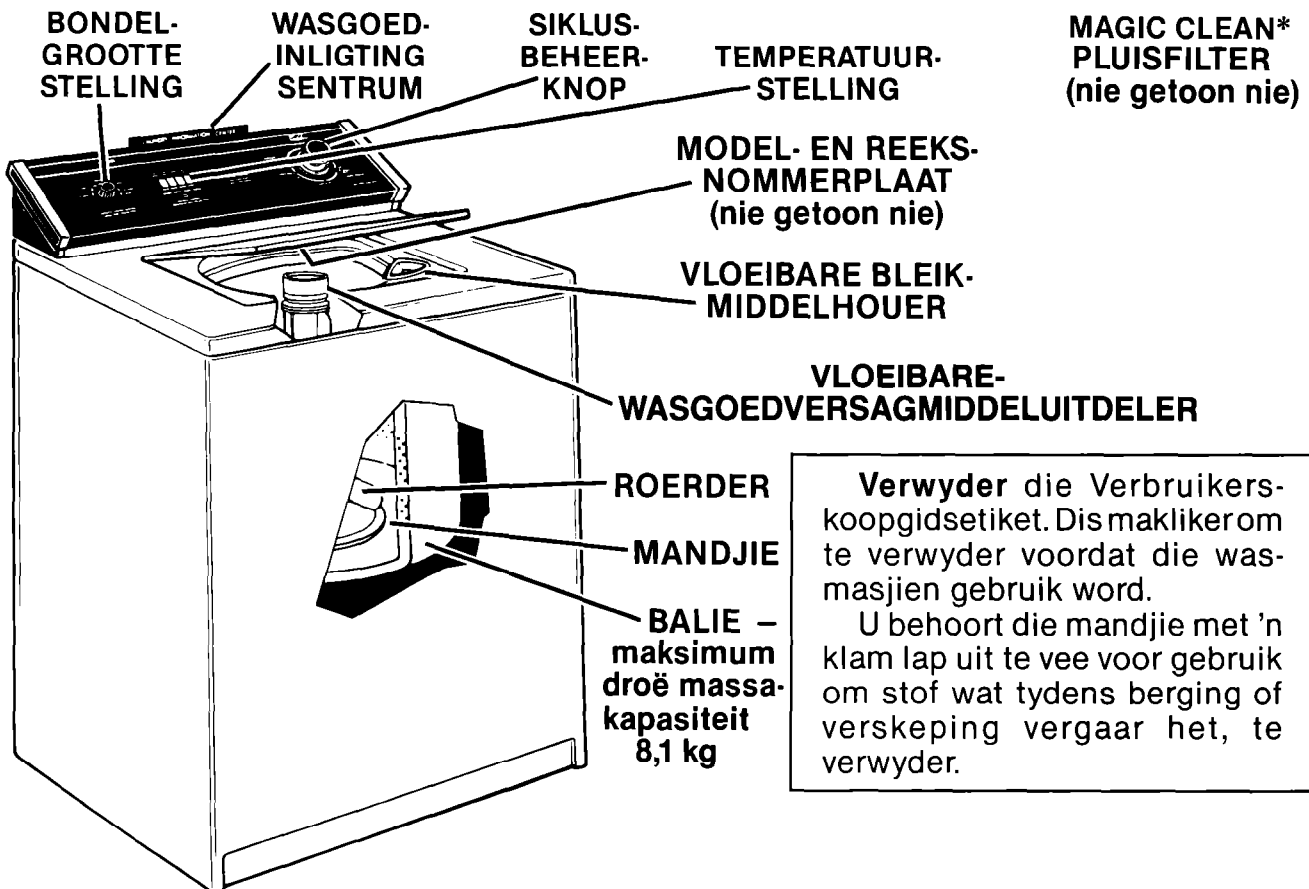

Teken u Model- en Reeksnommers hier aan:

Wanneer u diens of inligting verlang, moet u die volgende gegewens byderhand hê:

- Volledige** Model- en Reeksnommers (sien die plaat onder die deksel naby die skarnier.)
- Aankoopdatum op verkoopstrokie.

Teken hierdie inligting in die ruimtes hiernaas aan. Bewaar dié boekie, u "Wasgoedgids" en verkoopstrokie.

Modelnommer _____

Reeksnommer _____

Aankoopdatum _____

Diensmaatskappy _____
 Telefoonnommer _____

Belangrike veiligheidsmatreëls

⚠ WAARSKUWING

Om die risiko van brand, elektriese skok of besering te voorkom wanneer u wasmasjien in gebruik is, volg basiese voorsorgmatreëls, insluitend die volgende:

- **Lees alle aanwysings voordat u wasmasjien gebruik word.**
- **MOET NOOIT** items wat met was, verf, petrol of ontvlambare vloeistowwe skoongemaak, gewas, geweek of bevestig is, in die wasmasjien was nie. Die dampe kan 'n **GEVAAR VAN BRAND** of **ONTPLOFFING** veroorsaak. Was **ALTYD** wasgoed wat sodanige stowwe bevat met die hand en laat lugdroog word.
- **MOET NOOIT** toelaat dat kinders die wasmasjien gebruik, daarmee speel of daarin kruip nie. Streng toesig oor kinders is noodsaaklik as hulle in die nabyheid is tydens gebruik van die masjien.
- Wanneer u 'n ou wasmasjien weggooi, verwyder **ALTYD** die deksel om toevalige voorstrikking te voorkom.
- **MOET NOOIT** u hande in die wasmandjie terwyl die water loop in, terwyl die roerder beweeg of terwyl die mandjie wentel. Indien die deksel oopgemaak word terwyl die mandjie wentel, sal dit outomaties binne 'n paar sekondes gaan staan.
- **MOENIE** met die beheerknoppe peuter nie.
- **MOET NOOIT** ontvlambare vloeistowwe (droogskoonmaakmiddels, kerosen) in of naby u wasmasjien gebruik of berg nie. **MOENIE** ontvlambare vloeistowwe by die waswater voeg nie. Hierdie stowwe stel dampe vry wat 'n **GEVAAR VAN BRAND** of **ONTPLOFFING** kan veroorsaak.
- Indien warm water nie onlangs (in die reël 2 weke of langer) gebruik gewees het nie, waterstofgas mag in die waterverwarmer en in die warmwaterpype ophoop. **WATERSTOFGAS IS ONTPLOFBAAR.** Om besering of skade te voorkom, voordat u wasmasjien gebruik word, draai alle warmwaterkrane aan en laat die water vir 'n hele paar minute loop. Dit sal die ontleding van die gas toelaat. **MOENIE** rook of enige ope vlam gebruik naby die kraan terwyl dit oop is.
- **Verseker dat u wasmasjien:**
 - deur 'n gekwalifiseerde persoon geïnstalleer en herstel word en onderdeel deur so 'n persoon vervang word.
 - behoorlik gewaterpas en geïnstalleer is op 'n vloer wat die gewig kan dra.*
 - aan die korrekte driepenuitlaat, elektriese toevoer, watertoevoer en dreinerings gekoppel word.*
 - behoorlik geaard is.*
 - behoorlik in stand gehou word.*
 - teen die weer beskerm word en gehou word waar die temperatuur nie onder vriespunt sal daal nie.

*Sien die "Installeeraanwysings."

– BEWAAR HIERDIE AANWYSINGS –

Bykomende veiligheidsmatreëls en u verantwoordelikerde

Bewaar wasmiddels, washulpmiddels en ander stowwe **ALTYD** in 'n koel, droë plek en buite die bereik van kinders – verkieslik in 'n kas wat kan gesluit word.

Lees en volg **ALTYD** aanwysings op wasmiddel en washulpmiddelverpakkinge – veral waarskuwings en voorsorgmatreëls.

GEVAARLIKE DAMPE kan vrygestel word indien chloor-bleikmiddel in dieselfde was as ammoniak of sure soos asyn of roesverwyderaar gebruik word.

Ontkoppel **ALTYD** die kragtoevoerkoord voordat daar aan die wasmasjien gewerk word. **MOENIE** glasveselstowwe in die masjien was nie. Klein deeltjies kan in die materiaal van opvolgende wasbondels vassteek en velirritasies veroorsaak.

Verseker dat u wasmasjien:

- slegs vir take gewoonlik verwag van huishoudelike wasoutomate gebruik word.
- nie deur kinders of iedereen wat onbevoeg vir korrekte bedryf daarvan gebruik word nie.

Gebruiksaanwysings

Hoe om u wasmasjien aan te skakel



Gebruik lae-skuim wasmiddel geskik vir 'n outomatiese wasmasjien en meet die korrekte hoeveelheid uit. Plaas 'n gesorteerde wasbondel in die wasmasjien voordat die siklus aangeskakel word. Wasmiddel moet vooraf opgelos word indien die watertemperatuur laer as 40°C is.

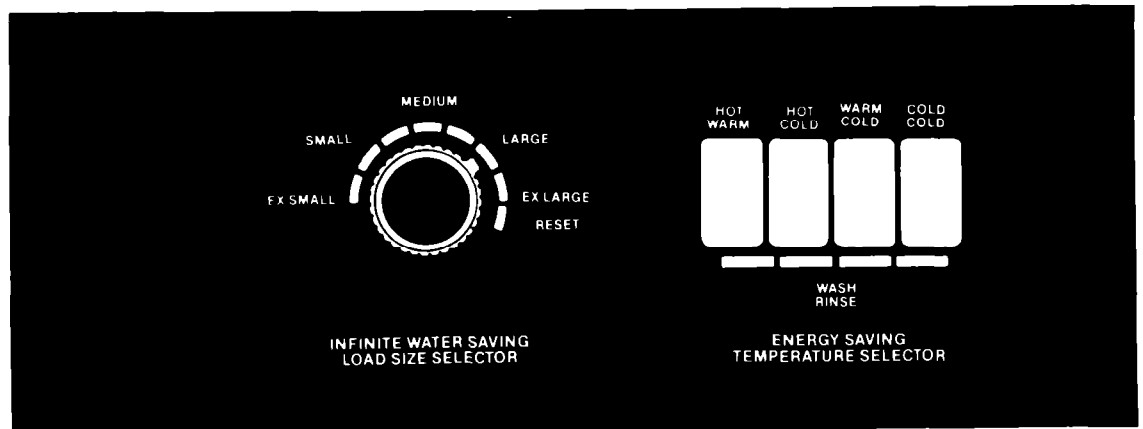

1. Kies BONDELGROOTTE

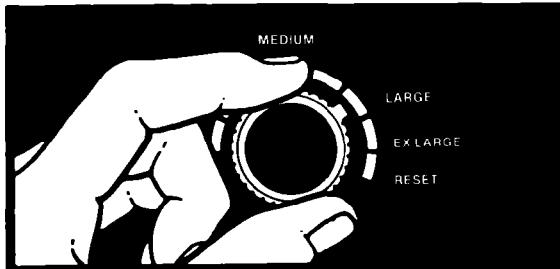

- Draai die knop na die stelling wat aanpas by die bondelgrootte.
- Stel die knop in enige posisie tussen "EX SMALL" ('n paar klein artikels) en "EX LARGE" ('n volle bondel).
- Om die watervlak te verander nadat die water begin inloophet, draai die knop na "RESET" en dan na die verlangde watervlak.

LET WEL: Gebruik die "EX LARGE" watervlak vir die beste kreukeltraag ("permanent press")-resultate.

2. Kies WATER-TEMPERATURE

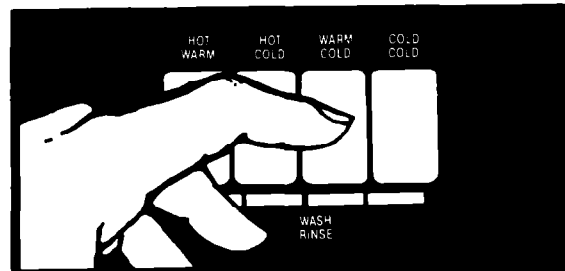

- Kies was- en spoelwatertemperatuur deur 'n knoppie te druk.
- Hierdie illustrasie toon 'n warm was (hoogste temperatuur) en koue spoel (laagste temperatuur) aan.

Aanbevole wastemperatuur verskyn in u 'Wasgoedgids'.

BELANGRIK: Gebruik warm water by die "PERM'T PRESS" of "KNITS/GENTLE" siklusse. Vir baie vuil kreukeltraag- of breistowwe, week voordat in warm water gewas word.

BONDELGROOTTES EN WATERVLAKKE

Vir die beste wasresultate moet die bondel vryelik in die water kan beweeg. 'n Bondel wat te groot is, of te min water, kan slytasie veroorsaak of wasgoed beskadig.

Benaderde watervlak vir bondel.

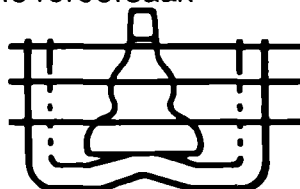

VERSIGTIG:
MOENIE WASMASJIE N OORLAAI NIE.

"EX LARGE" 82,1 l
"MEDIUM" 62,1 l
"EX SMALL" 45,0 l

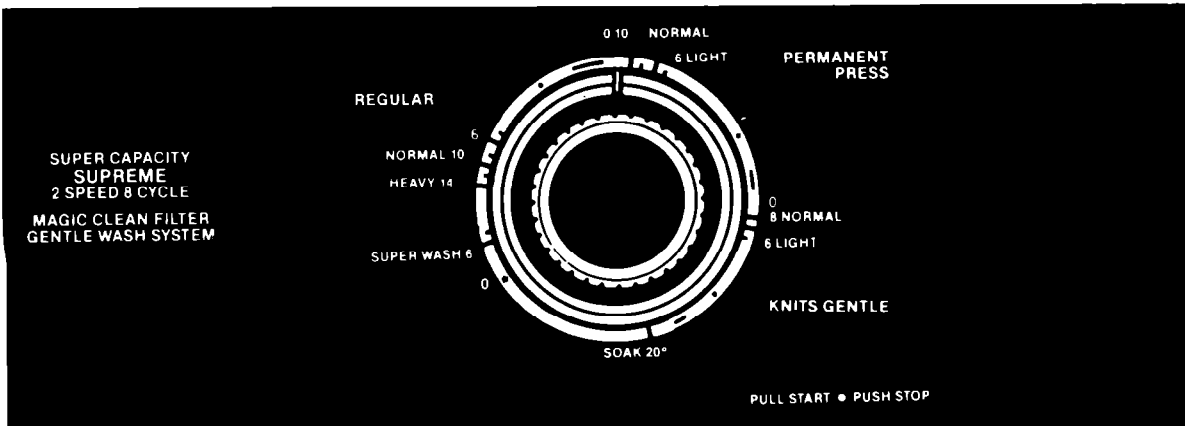

3. Kies SIKLUS en WASTYD; Skakel die wasmasjien aan

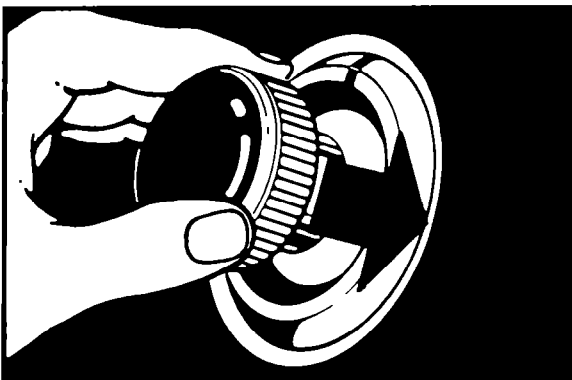

A. Druk die beheerknop in en draai na regs. Dit moet ingedruk word en slegs kloksgewys gedraai word.

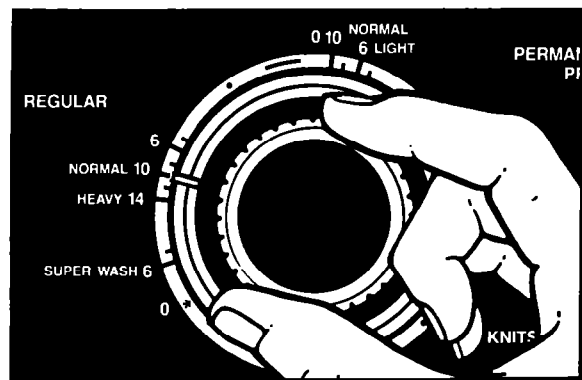

B. Stop by die verlangde nommer in die siklus. Die nommers stel die wastyd in minute voor. Die illustrasie toon 10 minute van roering in die REGULAR NORMAL-siklus.

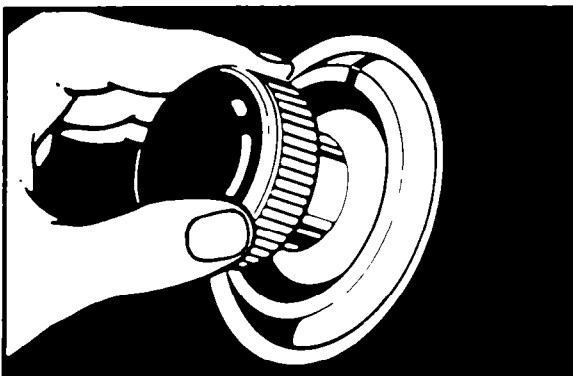

C. Skakel die wasmasjien aan deur die beheerknop uit te trek. Die wasmasjien sal inloop tot die verkose vlak met waswater van die gekose temperatuur. Nadat die wasmasjien gevul is, sal dit roer vir die bepaalde aantal minute.

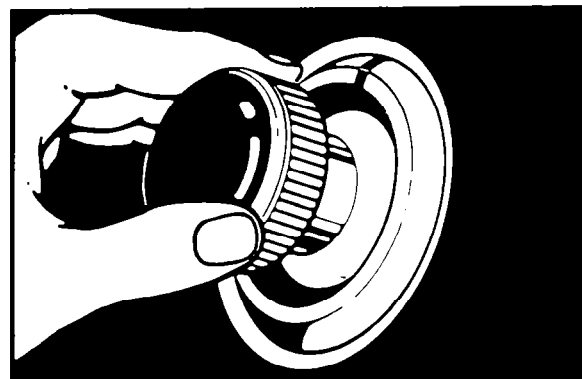

D. Om die wasmasjien te stop, kan die beheerknop enige tyd ingedruk word. Om die was te hervat, word die beheerknop uitgetrek.

Ander gebruiksaanwysings

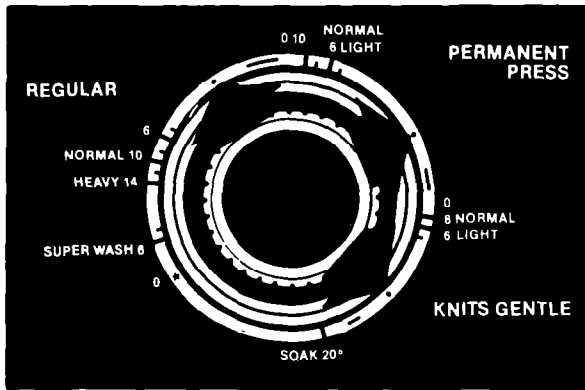

Vir spoel en wentel

'n Bykomende spoel- en wentelsiklus mag nodig wees vir baie vuil wasgoed wat meer wasmiddel vereis. (Bykomende wasmiddel kan 'n bykomende spoelsiklus vereis.)

1. Druk Beheerknop in.
2. Draai kloksgewys na enige ● op die paneel. **Sien illustrasie hierbo.**
3. Trek Beheerknop uit. Die wasmasjien sal tot verlangde vlak vul; 2 minute roteer; dreineer en wentel.

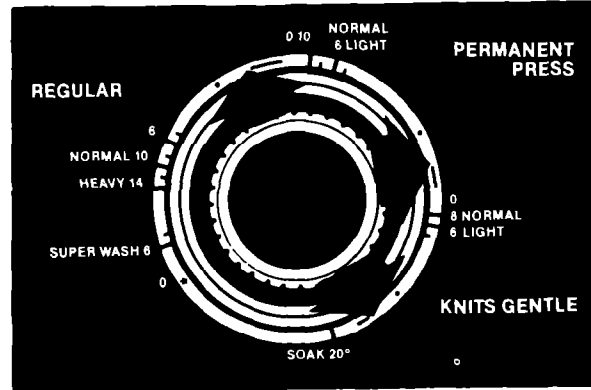

Vir dreinering en wentel

U wasmasjien kan gestel word om te dreineer en water uit te wentel.

1. Druk Beheerknop in.
2. Draai kloksgewys na die stasie net voor die AF-posisie in enige siklus. **Sien illustrasie hierbo.**
3. Trek Beheerknop uit. Die wasmasjien sal dreineer en wentel.

Om te week

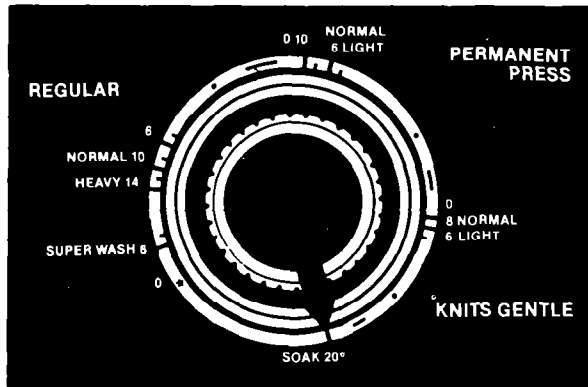

Vir beste resultate, gebruik **warm** ("Warm") water om gevlekte wasgoed te week of vooraf te was. **Baie warm** ("Hot") water kan vlekke laat set.

1. Gebruik voorgeskrewe hoeveelheid wasmiddel of vooraf-weekmiddel.
2. Druk Beheerknop in.
3. Draai kloksgewys om na die **nommer** in die "SOAK"-siklus te wys.
4. Trek Beheerknop uit. Die wasmasjien sal begin roteer.
5. Wanneer die weeksiklus voltooi is, voeg wasmiddel vir die volgende verlangde wassiklus by. **Die "SOAK"-siklus moet altyd deur 'n Wassiklus gevolg word.**

Belangrik: Sien bykomende versorgingsinligting in u "Wasgoedgids".

Vloeibare bleikmiddelhouer

Bleikmiddel moet uitgemeet word. Moenie raai nie. Moet nooit meer as 1 koppie (250 ml) vir 'n volle bondel gebruik nie. Gebruik minder met laer watervlak-stellings. Volg aanwysings op bottel vir veilige gebruik. Gebruik 'n koppie met skinktuit om storting te voorkom.

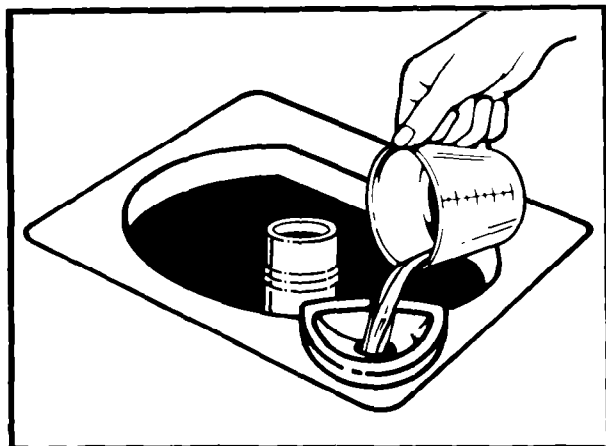
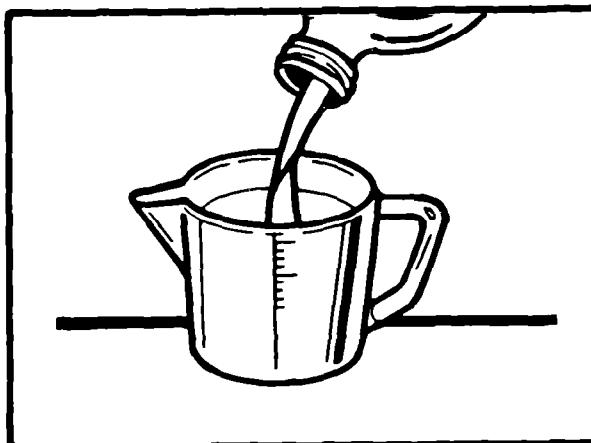

1. Laai eers die wasmasjien.
2. Giet **afgemaete** bleikmiddel versigtig in houer. **MOENIE** dat bleikmiddel spat, drup of in die wasmasjien-mandjie loop nie. **Onverdunde bleikmiddel sal enige materiaal waarmee dit kontak maak, beskadig.**
3. Skakel wasmasjien aan. Bleikmiddel sal outomaties gedurende die was-siklus verdun word.

Vir nadere inligting omtrent bleik, sien u "Wasgoedgids".

MAGIC CLEAN* pluusfilter

Die pluusfilter in u wasmasjien is selfreinigend. Pluis wat opgaar, word saam met die was- en spoelwater gedreineer.

Indien u wasmasjien in 'n balie dreineer, moet pluis wat in die riool of rooster versamel, verwyder word.

Houer vir vloeibare wasgoedversagmiddel

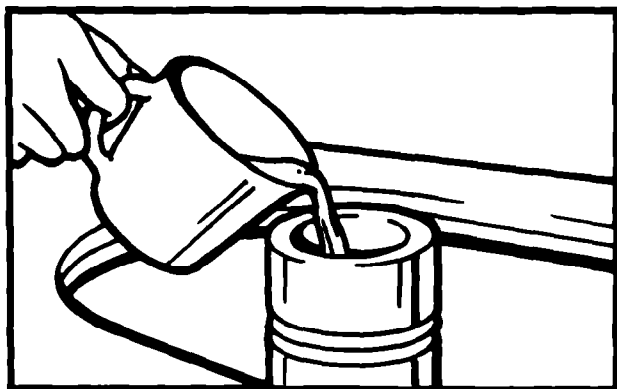

1. Plaas wasmiddel en bondel in die mandjie.
2. Meet voorgeskrewe hoeveelheid versagmiddel (sien verpakking) in die houer uit.
3. Moenie versagmiddel op bondel laat drup of stort nie.
4. **Verdun** versagmiddel met warm water. Die hoeveelheid verdunde versagmiddel moenie 150 ml per vulling oorskry nie.
5. Skakel wasmasjien aan. Verdunde versagmiddel sal gedurende die eindspoel deel van die siklus by die bondel gevoeg word. **LET WEL: Moenie die wasmasjien tydens hierdie siklus afskakel nie.** Indien u dit doen, sal die versagmiddel met die oorblywende seepwater meng. Dit sal vlekke veroorsaak. **Moenie wasmiddel in die vloeibare-versagmiddelhouer plaas nie.**
6. Indien houer reiniging vereis, spoel met baie warm water.

Programgids



	MATERIAAL	WERKING	BONDEL-GROOTTE	WAS-MIDDELS	WATERTEMP. WAS/SPOEL	PROGRAM-STELLING	BLEIK-MIDDEL	VERSAG-MIDDEL
1.	Baie vuil natuurlike vesels, bv: linne of wit katoen	8-min. Hoë-Spoed-Was 6-min. Lae-Spoed-Was 2-min. Hoë-Spoed-Wentel 1 Spoel 2 Sproei-Spoele 6-min. Finale Hoë-Spoed-Wentel	Soos per bondel	Verwys Wasgoed-gids	"Hot"/"Warm"	"Regular Heavy" Nr - 14	Ja	Ja
2.	Baie vuil natuurlike vesels, bv: linne, katoen, denim en kleurvaste materiale	8-min. Hoë-Spoed-Was 6-min. Lae-Spoed-Was 2-min. Hoë-Spoed-Wentel 1 Spoel 2 Sproei-Spoele 6-min. Finale Hoë-Spoed-Wentel	Soos per bondel	Verwys Wasgoed-gids	"Hot"/"Warm"	"Regular Heavy" Nr - 14		Ja
3.	Normale vuil natuurlike vesels, bv: linne, katoen, denim en kleurvaste natuurlike vesels	4-min. Hoë-Spoed-Was 6-min. Lae-Spoed-Was 2-min. Hoë-Spoed-Wentel 1 Spoel 2 Sproei-Spoele 6-min. Finale Hoë-Spoed-Wentel	Soos per bondel	Verwys Wasgoed-gids	"Hot"/"Cold"	"Regular Normal" Nr - 10		Ja
4.	Taamlke vuil kreukeltrae materiale en gemengde kleurvaste materiale	4-min. Hoë-Spoed-Was 6-min. Lae-Spoed-Was 1 Afkoel-Inname 2-min. Hoë-Spoed-Was 2-min. Hoë-Spoed-Wentel 1 Spoel 2 Sproei-Spoele 4-min. Finale Lae-Spoed-Wentel	Ekstra Groot	Verwys Wasgoed-gids	"Warm"/"Cold"	"Permanent Press Normal" Nr - 10		Ja
5.	Effense vuil kreukeltrae materiale en gemengde kleurvaste wasgoed	6-min. Lae-Spoed-Was 1 Afkoel-Inname 2-min. Hoë-Spoed-Was 2-min. Hoë-Spoed-Wentel 1 Spoel 2 Sproei-Spoele 4-min. Finale Lae-Spoed-Wentel	Ekstra Groot	Verwys Wasgoed-gids	"Warm"/"Cold"	"Permanent Press Light" Nr - 6		Ja
6.	Taamlke vuil ligte artikels en wasbare brelstowwe	8-min. Ligte-Was 2-min. Hoë-Spoed-Wentel 1 Spoel 2 Sproei-Spoele 4-min. Finale Lae-Spoed-Wentel	Ekstra Groot	Verwys Wasgoed-gids	"Warm"/"Cold"	"Knits/Gentle" "Normal" Nr - 8		Ja
7.	Effense vuil ligte artikels en wasbare breistowwe	6-min. Ligte-Was 2-min. Hoë-Spoed-Wentel 1 Spoel 2 Sproei-Spoele 4-min. Finale Lae-Spoed-Wentel	Ekstra Groot	Verwys Wasgoed-gids	"Warm"/"Cold"	"Knits/Gentle" "Light" Nr - 6		Ja
8.	Baie vuil wasgoed met viekke wat bykomende vooraf-behandeling vereis. Hierdie siklus moet deur 'n wassiklus opgevolg word	4-min. Hoë-Spoed-Was 4-min. Week 2-min. Hoë-Spoed-Was 4-min. Week 6-min. Hoë-Spoed-Was 2-min. Finale Hoë-Spoed-Wentel	Soos per bondel	Was-middel of Voor-weekmid-del	"Warm" of "Cold"	"Soak"-siklus Nr - 20		
9.	Baie vuil wasgoed wat maksimum reiniging vereis. Hierdie siklus volg gewoonlik op die weeksiklus	4-min. Hoë-Spoed-Was 1 Gedeeltelike Dreinerings en vooruitstelling na die "Heavy Regular"-siklus (Nr 14)	Soos per bondel	Dubbel-hoeveelheid Was-middel	"Hot"/"Cold"	"Super Wash" Nr - 6		

Versorging van u wasmasjien

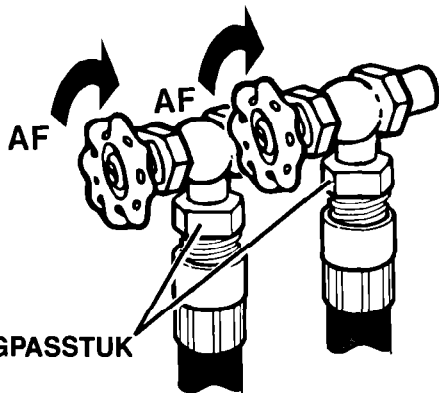

SLANGPASSTUK

WANNEER NIE GEWAS WORD NIE, draai beide waterkrane toe om druk op die waterkleppe uit te skakel.



Droog spatsels onmiddellik af. Spatsels kan die afwerking laat verdof of beskadig.

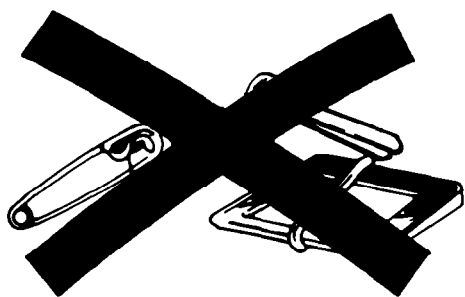

VERWYDER SKERP VOORWERPE soos spelde, gespes, ens., voor klere gewas word. Maak metaalritssluiters toe.

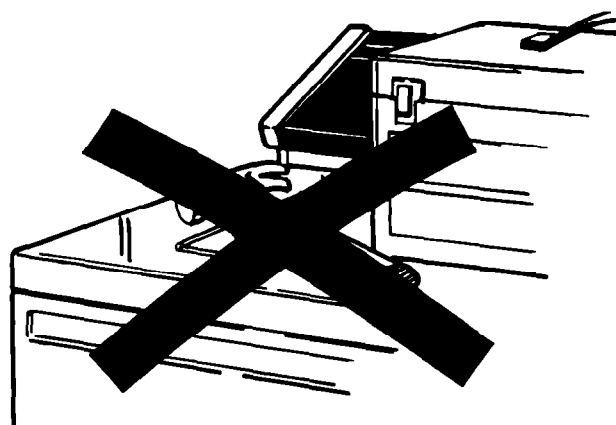

SKERP OF SWAAR VOORWERPE moet nooit op of in die wasmasjien geplaas word nie. Kontroleer sakke vir skroewe, moere, gereedskap, ens.



MOET NOOIT DIE WASMASJIE
GEBRUIK OM . . .

- nat of droë wasgoed te berg nie.
- vir meer as 2 uur te week nie.
- met chloor-bleikmiddel te week nie.
- met asyn of ander sure te week nie.
- **wasgoed wat urine bevat te week of te berg nie.**



SEKERE VOOR-BEHANDELINGSPRODUKTE kan wasmasjien- en droërpanele, konsoles en afwerking beskadig. Moenie hierdie produkte op of naby u wasmasjien of droër gebruik nie.

Aanbevole stappe indien u diens of hulp nodig het:

1. Voordat u hulp ontbied . . .

Werkverrigting word dikwels deur klein probleme belemmer wat u self kan opspoor en sonder gereedskap van enige aard kan regstel.

Indien u wasmasjien nie vul nie:

- Is die kragtoevoerkoord met 'n lewendige stroom van die vereiste spanning verbind?
- Is beide waterkrane oop?
- Het u u huis se hoofsekerings of stroombrekerbord nagegaan?
- Is die watertoevoerpipe gekink?
- Is die Siklusbeheerknop gestel en uitgetrek?

Indien u wasmasjien nie wentel nie:

- Is die deksel toe?
- Is die kragtoevoerkoord met 'n lewendige stroom van die vereiste spanning verbind?
- Het u u huis se hoofsekerings of stroombrekerbord nagegaan?

Indien u wasmasjien gedurende 'n siklus tot stilstand kom:

- Onthou dat u wasmasjien vir 'n kort tydjie op verskillende tye in elke siklus tot stilstand kom. Hierdie pouses is normaal.

Indien u wasmasjien volloop en dreineer sonder om te roteer:

- Maak seker dat die Sikluskontroleknop na 'n nommer op die siklus wys.

Maak seker dat die dreineerpyp hoër is as die watervlak in die wasmasjien.

Indien nié:

- mag die wasmasjien gedurende was- en spoelsiklusse dreineer.
- kan water lek. (Sien "Installering-handleiding".)

2. Wanneer u verhuis . . .

Om seker te maak dat u toestel behoorlik geïnstalleer word en om voortgesette bevredigende werking te verseker, skakel u handelaar. (Instaleringkoste sal natuurlik deur u betaalbaar wees.)

3. Nuttige wenke . . .

U kan die diens van u diensverteenvoordige bespoedig deur die model- en reeksnommer van u toestel te verstrek wanneer u diens versoek. Bewaar ook u verkoopstrokie en waarborg om u waarborgstatus te bewys.

Onthou . . . U diensverteenvoordiger is opgelei om u Whirlpool-toestel te versien of te herstel. Hy kan u help om die gehalte wat oorspronklik in u WHIRLPOOL-toestel ingebou is, te handhaaf. Slaan dus sy telefoonnommer na en **teken dit aan die ruimte wat op bladsy 2 voorsien word.**

4. Indien u diens nodig het . . .

Die versorging van u Whirlpool wasmasjien word aan die landwye diensnetwerk van K.I.C. Beperk toevertrou – die maatskappy wat Nr 1 gewaarborgde naverkoopdiens.

U K.I.C.- DIENSSENTRUMS IS IN:

KAAPSTAD	(021) 25-2070
JOHANNESBURG	(011) 887-6610
DURBAN	(031) 700-4361
PORT ELIZABETH	(041) 54-3484
BLOEMFONTEIN	(051) 32-4733/4
KIMBERLEY	(0531) 81-2588
WINDHOEK	(061) 3-8925

Met dien verstande dat u nie verder as 50 km van u naaste K.I.C.-dienssentrum geleë is nie, sal geen reiskoste gehef word as u toestel nog onder waarborg is nie. Enige reiskoste vir afstande verder as dié 50 km-radius sal vir die eienaar se rekening wees.

Die vervaardigers behou die reg om te alle tye sonder voorafkennisgewing hul produkte te wysig of te verander.

Waarborg deur K.I.C. Beperk

Die artikel geïdentifiseer op die reeksetiket/plaat word vir 24 maande se normale gebruik en diens vanaf datum van aankoop teen defekte as gevolg van foutiewe materiale en vakmanskap deur K.I.C. aan die oorspronklike koper gewaarborg, onderworpe aan die voorwaardes van klousules 1 tot 13 hieronder:

- 1.1 K.I.C. sal te eniger tyd onder die waarborgtydperk verantwoordelikheid aanvaar vir die vervanging of herstel van enige onderdeel wat deur K.I.C. foutief bevind word.
- 1.2 'n Onderdeel/onderdele sal volgens K.I.C. se uitsluitlike diskresie herstel in plaas van vervang word.
2. In die geval waar 'n defek aan 'n artikel ingevolge hierdie waarborg herstel moet word, sal geen reiskoste of -tyd gehef word indien die artikel binne 50 km van 'n K.I.C. tak of die naaste K.I.C. aangewese hersteller geleë is nie. Reiskoste en reistye na plekke buite die 50 km radius sal volgens K.I.C. (of sy aangewese hersteller waar toepaslik) se heersende tariewe van tyd tot tyd, deur die eienaar aan K.I.C. of die hersteller betaalbaar wees. Dié heffing word bereken op die kilometers wat die 50 km-toegewing oorskry en is mutatis mutandis van toepassing op die diensingenieur se retoerreis.
3. Ondanks enige teenstrydige bepaling hierin vervat, moet die defek uitsluitlik aan foutiewe materiale of foutiewe vervaardiging te wyte wees.
4. Die waarborg sluit defekte uit wat die gevolg is van versuim om aan die instruksies in hierdie boekie te voldoen; verkeerde stroomsterkte of defekte in die elektriese kragstelsel; skade veroorsaak deur weerlig, stakings, misbruik of wangebruik van die artikel; gebruik van die artikel vir doeleindes buiten dié waarvoor dit ontwerp is; vuur, vloedskade, oorlog, burgerlike onrus, industriële aksie, natuurrampe, of enige ander oorsaak buite die redelike beheer van K.I.C.
- 5.1 K.I.C. aanvaar onder geen omstandighede aanspreeklikheid vir enige skade gelyk wat die gevolg is van nie-werking of foutiewe werking van die artikel, of vir gevolglike skade van watter aard ook al, of wat ook al die oorsaak nie.
- 5.2 Sonder om van die algemene strekking van die voorafgaande af te wyk, aanvaar K.I.C. nie aanspreeklikheid vir enige skade veroorsaak deur die foutiewe werking en/of skade van/aan die artikel wat voortspruit uit vreemde voorwerpe wat in die werkende onderdele van die artikel beland nie, bv. 'n muntstuk wat die pomp van 'n wasmasjien blokkeer.
6. Die waarborg dek nie sekerings, stilus, uitwendige kragproppe, kables, plastiek-, rubber- en glasonderdele nie, of waar 'n artikel wat vir normale huishoudelike gebruik ontwerp is, vir kommersiële of enige ander doel gebruik word waarvoor dit nie ontwerp is nie.
7. Hierdie waarborg is verder ongeldig in die geval waar die artikel uitmekaargehaal/versien/herstel/verander is deur enige iemand anders as K.I.C. of sy aangewese hersteller, of enige ander party wat deur K.I.C. daartoe gemagtig is; of in die geval waar die reeksetiket/plaat geskend of verander is.
8. Die waarborg is van toepassing op die artikel op die voorwaarde dat dit steeds in besit en gebruik is van die oorspronklike koper en verder dat dit gekoop en gebruik is in die Republiek van Suid-Afrika, Swaziland, Lesotho, Botswana, Namibië, Transkei, Ciskei, Venda, Bophuthatswana, Lebowa.
9. Enige foutiewe onderdeel wat vervang word, sal die eiendom van die hersteller wees.
10. In die geval van 'n kontantaankoop (in teenstelling met 'n kredietooreenkoms onderworpe aan die voorwaardes van die Wet op Kredietooreenkoms, 1980, of enige wysiging of vervangende wetgewing) vervang hierdie waarborg enige gemeenregtelike aanspreeklikheid deur K.I.C. wat betref latente defekte.
11. Herstelwerk of onderdele wat vervang word ooreenkomstig hierdie waarborg word slegs deur die waarborg gedek vir die duur van die balans van die oorspronklike waarborgtydperk van toepassing op die artikel.
12. Die koper erken hiermee dat geen voorstellings of waarborge anders as dié wat hierin uiteengesit word, deel van die koopkontrak of verkoop van hierdie artikel vorm of die koper aangespoor het om hierdie artikel te koop nie.
13. Ten einde voordeel uit hierdie waarborg te trek, moet bewys van die datum van aankoop deur die koper gelewer word wanneer daar op die voordele aanspraak gemaak word.

*Geregistreeerde handelsmark van Whirlpool Corporation